

Standard Dimensions:x

The following are standard dimensions unless otherwise stated.

All dimensions subject to commercial tolerance.

- Hole Size: 14mm diameter
- Hole Spacing (From End): 20mm from end of fitting
- Hole spacing (On Center): 48mm center to center
- Fitting Width: 40mm

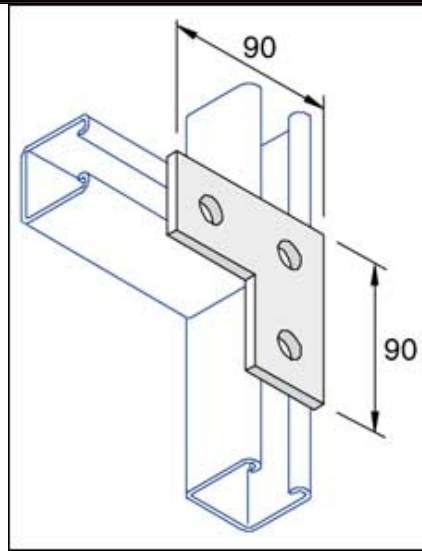

| Part No. | Finish | Weight | Box Qty |
|----------|--------|--------|---------|
| P1036 | HG | 0.21 | 25 |
| P1036 | SS | 0.21 | 25 |

Project: _____

Architect / Engineer: _____

Date: _____ Phone: _____

Contractor: _____

Address: _____

Notes 1: _____

Approval Stamp: