

Standard Dimensions:x

The following are standard dimensions unless otherwise stated.

All dimensions subject to commercial tolerance.

- Hole Size: 14mm diameter
- Hole Spacing (From End): 20mm from end of fitting
- Hole spacing (On Center): 48mm center to center
- Fitting Width: 40mm

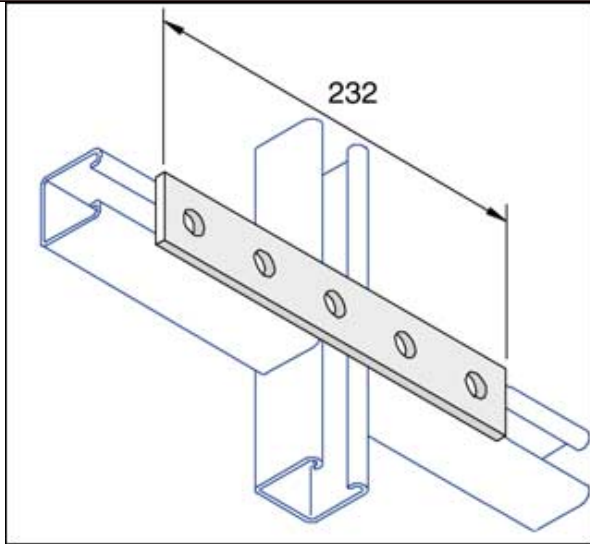

Part No.	Finish	Weight	Box Qty
P1941	HG	0.42	25
P1941	SS	0.34	25

Project: _____

Approval Stamp:

Architect / Engineer: _____

Date: _____ **Phone:** _____

Contractor: _____

Address: _____

Notes 1: _____
